

# Finewoods

SERIES

MODEL: FW1350  
AV SUPPORT

## ASSEMBLY INSTRUCTIONS

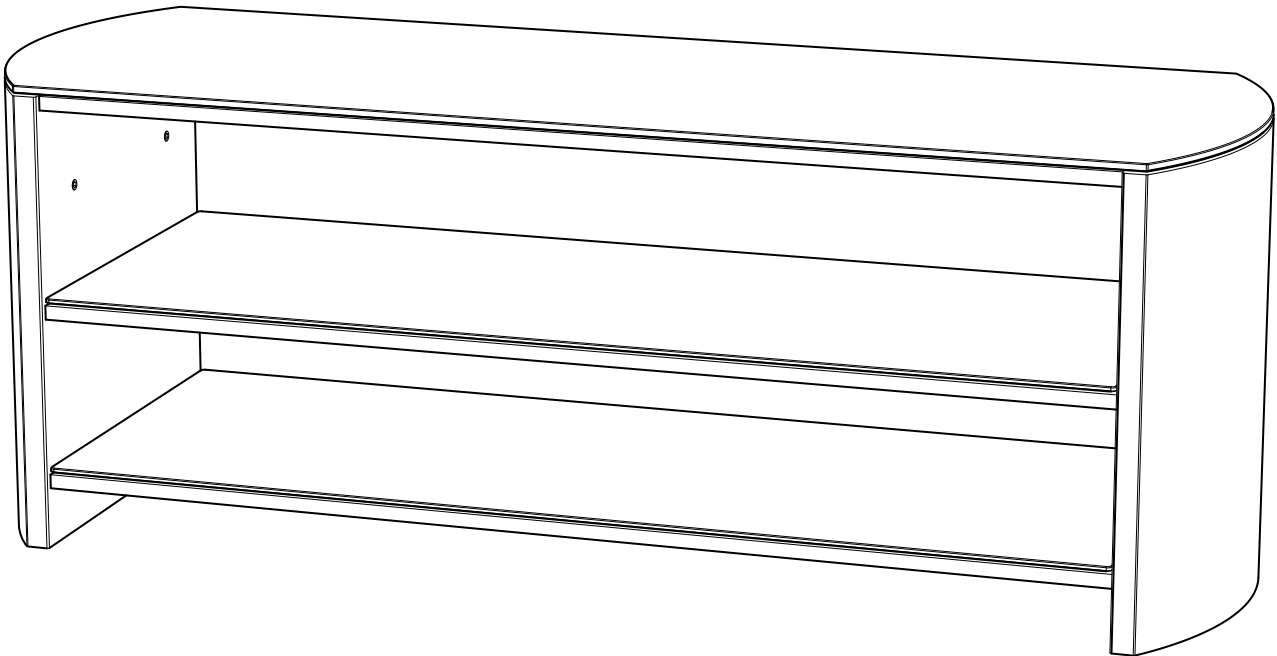

### IMPORTANT INFORMATION!

- 1) Before starting assembly please take time to familiarise yourself with the instructions and the components listed on the back page, as this product could be unstable if incorrectly installed.
- 2) Do not place hot or cold items against or in close proximity to any glass surface unless an adequately thick insulating material is used to prevent such items coming into contact with the glass.
- 3) Do not strike the glass with hard or pointed items.
- 4) When cleaning glass panels use a damp cloth or leather with washing up liquid or soft soap if necessary; do not use washing powders or other substances containing abrasives as these may scratch the glass.
- 5) Do not sit or stand upon horizontal glass surfaces.
- 6) In order to maintain a high quality finish, when cleaning wooden panels please use a soft cloth with a suitable furniture polish if required.
- 7) Alphason Designs uses real wood veneers, consequently slight colour and pattern variation may occur and does not indicate a product defect. With natural wood, exposure to direct sunlight can produce colour change and should be avoided. Any slight change in colour over time does not indicate a product defect.

#### Please Note:

**Total maximum load for this support must not exceed 120Kg**  
**This support must be assembled in accordance with these assembly instructions.**  
**Maximum load for top panel is 80Kg. Maximum load for each glass shelf is 50kg.**

Alphason Designs Ltd. accepts no liability for any damage caused through incorrect or inappropriate use of this audio visual support.

#### Alphason Designs Limited

Alphason House, Bolton Road, Atherton, Greater Manchester M46 9AW UK  
Tel: +44 (0)1942 885600  
Fax: +44 (0)1942 876955  
info@alphasondesigns.com

[www.alphasondesigns.com](http://www.alphasondesigns.com)

## STAGE 1

- Insert levelling feet **H** in the base of left side panel **A** and right side panel **B**.

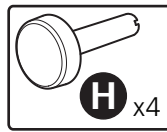

1.

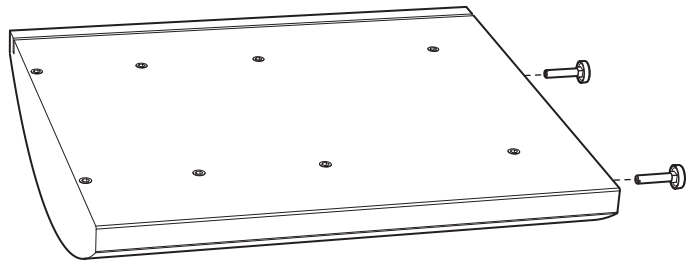

2.

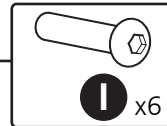
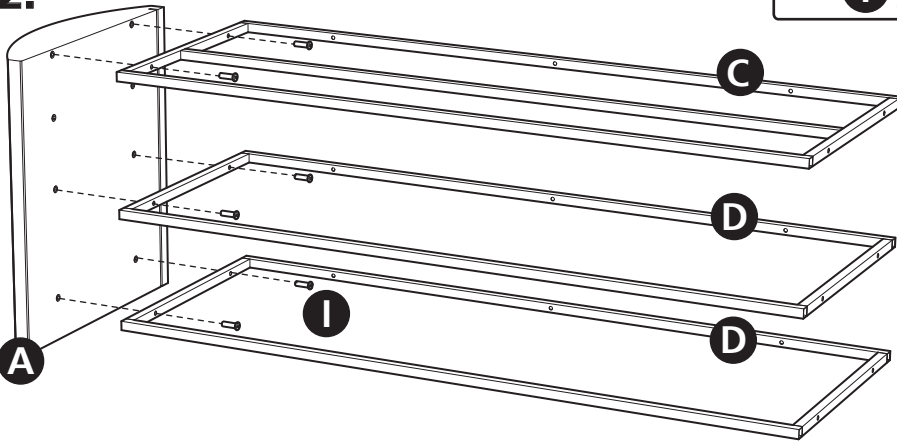

## STAGE 2

- Attach top shelf frame **C** to left side panel **A** using screws **I**.
- Please note top shelf frame has extra bar across the centre.
- Attach shelf frames **D** to left side panel **A** using screws **I** at the desired heights.
- Ensure holes in shelf frames are at the back for the back panel to fit at stage 3.

3.

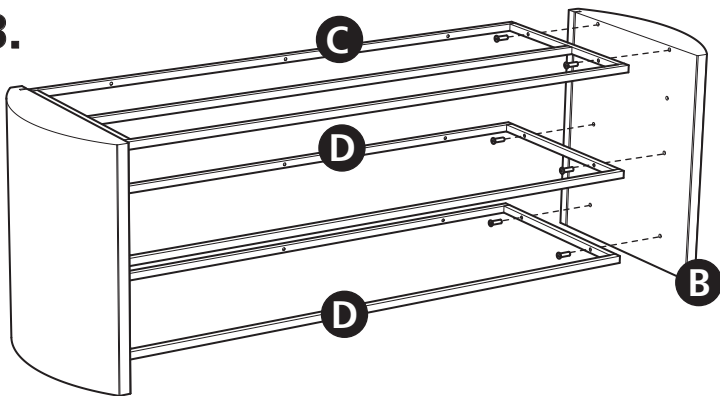

## STAGE 3

- Attach shelf frames **C** and **D** to right side panel **B** using screws **I**.

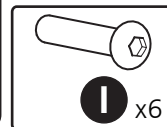

4.

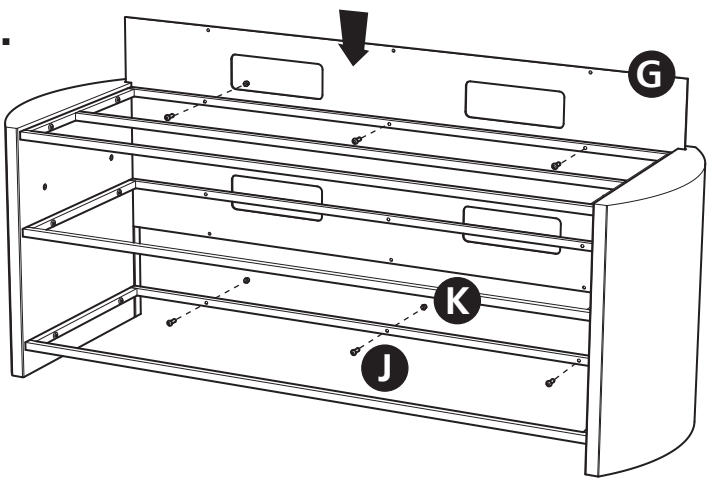

## STAGE 4

- Attach back panel **G** using screws **J** and dome nuts **K**.
- Ensure you slot back panel **G** into side panel grooves at both sides.
- Locate screws **J** through top and bottom framework **C** and **D**.

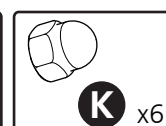
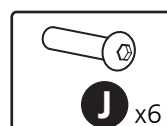

## STAGE 5

- Fix top shelf buffers **M** to top shelf frame **C**. Please space the buffers equally around the frames and ensure all top shelf buffers are used.
- Fix shelf buffers **N** to shelf frames **D**. Please space the buffers equally around the frames

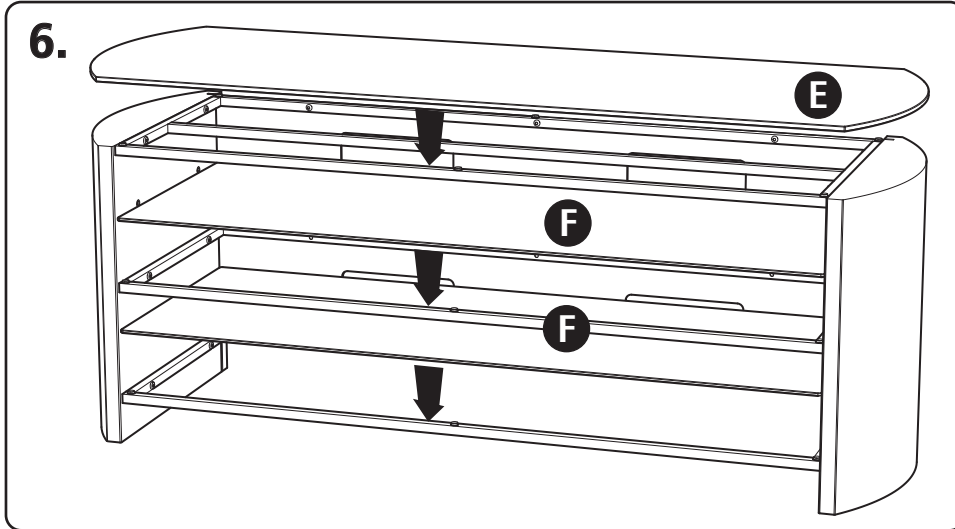
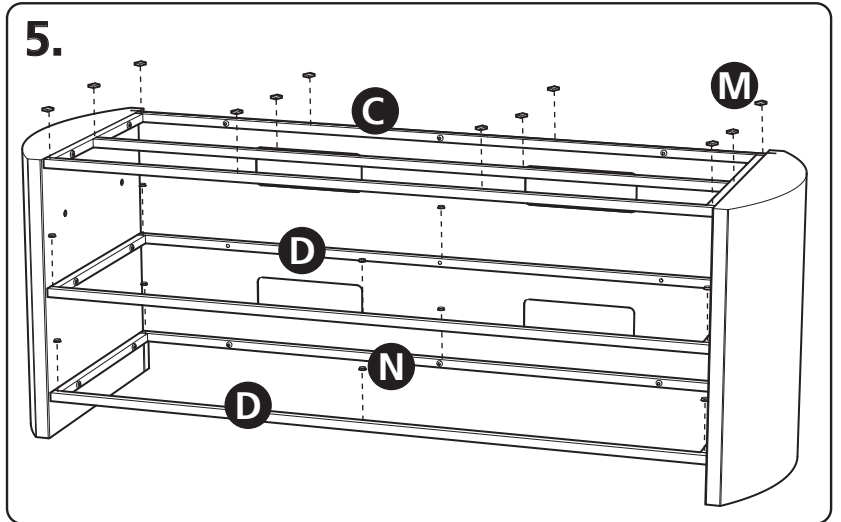
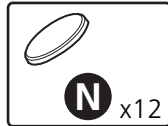
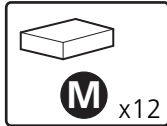

## STAGE 6



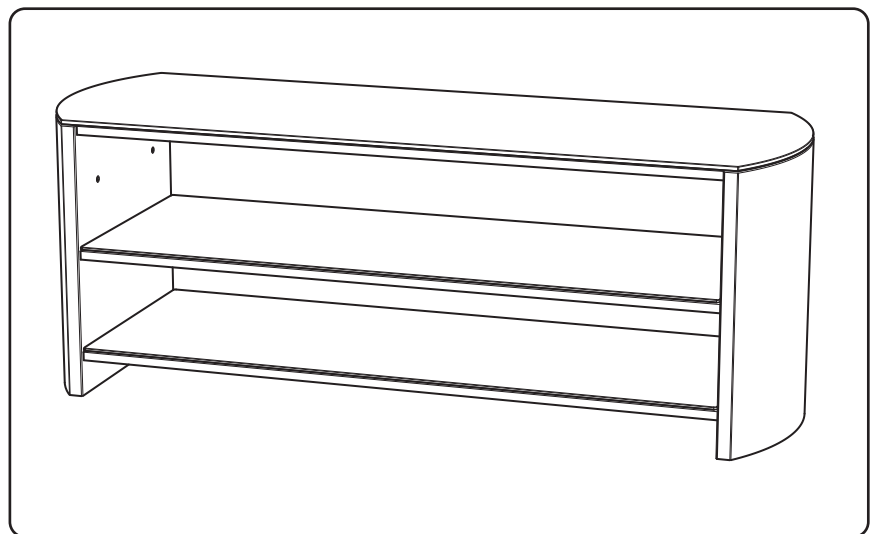

- Carefully place top glass shelf **E** onto top shelf frame **C**.
- Carefully place glass shelves **F** on to shelf frames **D**.
- Ensure all glass shelves are resting on buffers **M**.

Congratulations your stand is now complete.

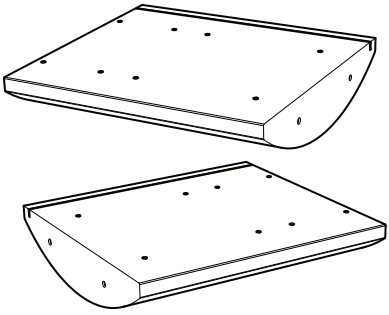
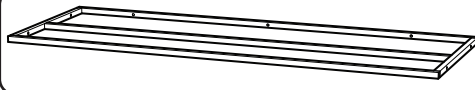

MODEL: FW1350

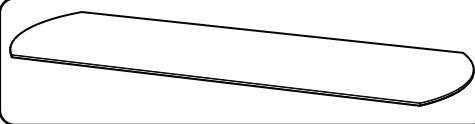
## CERTIFICATE OF CONFORMITY

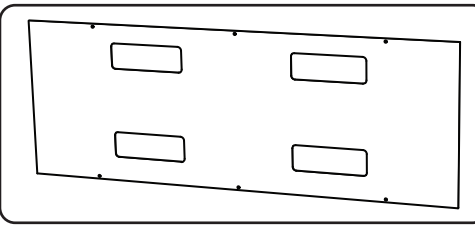
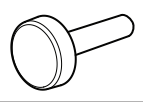
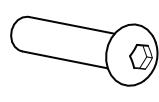
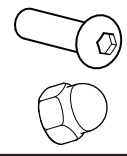
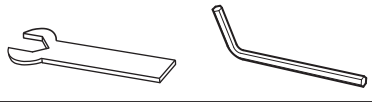
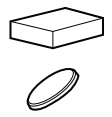
COMPONENT	DESCRIPTION	QTY	PACKED BY
	<p><b>A</b> LEFT SIDE PANEL</p> <p><b>B</b> RIGHT SIDE PANEL</p>	<p>1</p> <p>1</p>	
	<p><b>C</b> TOP SHELF FRAME</p>	<p>1</p>	
	<p><b>D</b> SHELF FRAMES</p>	<p>2</p>	
	<p><b>E</b> TOP GLASS SHELF</p>	<p>1</p>	
	<p><b>F</b> GLASS SHELVES</p>	<p>2</p>	
	<p><b>G</b> BACK PANEL</p>	<p>1</p>	
	<p><b>H</b> LEVELLING FOOT</p>	<p>4</p>	
	<p><b>I</b> M6 X 33 SCREW</p>	<p>12</p>	
	<p><b>J</b> M4 X 19 SCREW</p> <p><b>K</b> DOME NUT</p>	<p>6</p> <p>6</p>	
	<p><b>L</b> SPANNER AND ALLEN KEY</p>	<p>1</p>	
	<p><b>M</b> TOP SHELF BUFFERS</p> <p><b>N</b> SHELF BUFFERS</p>	<p>12</p> <p>12</p>	